

Application of The Reverse Engineering In The Modelling of A Blade and Screen In A Hammer Mill

Annisa Haq¹, Agus Kusnayat^{2*}, Sri Martini³

¹School of Industrial and System Engineering
Telkom University, Bandung, Indonesia
annisahaq@student.telkomuniversity.ac.id

²School of Industrial and System Engineering
Telkom University, Bandung, Indonesia
guskus@telkomuniversity.ac.id

³School of Industrial and System Engineering
Telkom University, Bandung, Indonesia
srimartini59m@gmail.com

*guskus@telkomuniversity.ac.id

ARTICLE INFO

Article history:

Received 29 December 2022
Accepted 30 January 2023
Published 31 January 2023

ABSTRACT

PT XYZ plans to produce coconut shell briquettes. Currently, PT XYZ already has a hammer mill machine that will be used in the production process. A hammer mill machine is a machine that serves to smooth the material. Before carrying out mass production, a simulation is carried out first. The manufacture of briquettes found obstacles in the process of grinding and screening. Coconut shell charcoal that has been milled and entered is partially retained and cannot be released to proceed to the next process. The grinding result is larger than the screen size, which is 1 to 2 mm. In the manufacture of briquettes, it is expected that the grinding results are less or equal to 0.4 mm. Based on the identification of the problem, the alternative solution chosen by the researcher is to redesign the hammer mill machine, especially on the blade and screen sections. The design is done using the reverse engineering method. There are five steps in designing using this method. In the study, it was found that the second design was a suitable design to be developed because it was better than the existing state. The mill results were obtained with an average of 0.0343 mm and a grinding time of 186.807 seconds. The fineness values and the grinding process time were obtained through simulations using the EDEM 2022.1 software.

Keywords:

blade; coconut shell; hammer mill; screen; size

This is an open-access article under the [CC BY-NC-SA](https://creativecommons.org/licenses/by-nc-sa/4.0/) license.



1. INTRODUCTION

Energy is an important aspect of life so today it can be classified as a primary need [1]. Based on the source, energy can be classified into two types, namely fossil-based energy and renewable energy. In 2021, the use of national primary energy is dominated by fossil-based energy such as oil, coal, and natural gas by 90.7% [2]. High dependence on fossil energy sources is the main problem in the national energy supply. The increasing demand for energy from year to year is not proportional to the production and availability of supply so Indonesia is likely to experience an energy crisis.

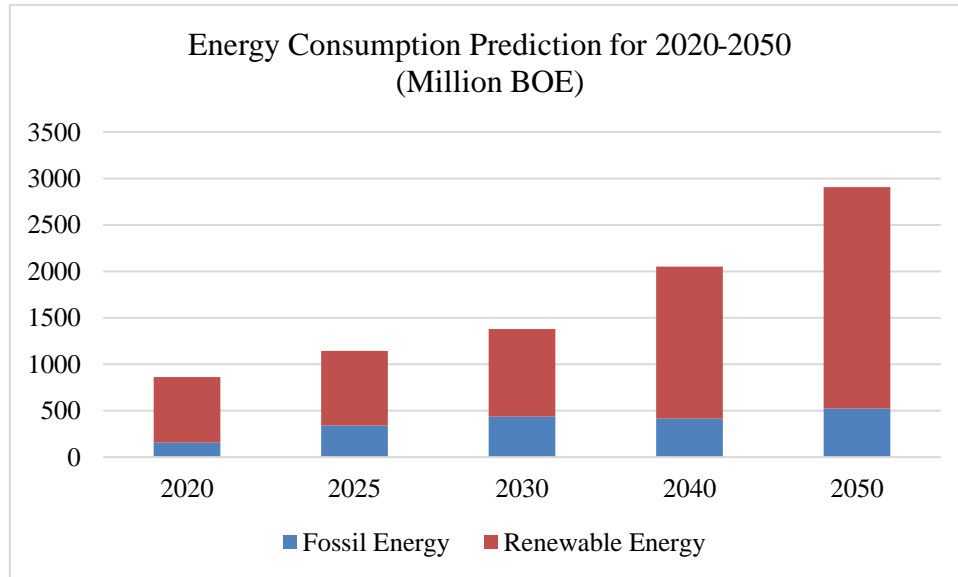

Figure 1 - Energy Consumption Prediction for 2020-2050

Based on the BAU (Business As Usual) scenario, the prediction of national energy consumption in 2020-2050 is expected to increase with an average growth rate of 3.5% per year for both fossil and renewable energy [2]. By seeing this opportunity, the government implemented KEN (National Energy Policy) and the Paris Agreement to reduce the use of fossil energy by making further use of renewable energy. One energy source that is currently in great demand is briquettes using coconut shells as the basic ingredient [9].

Indonesia is the largest coconut-producing country in the world, amounting to 17.3 million tons. Based on the amount of coconut production, the availability of coconut shells as raw material for briquettes is also abundant. Coconut shell is considered the best briquette material because it has a carbon content of 76.32% when it is turned into charcoal, relatively higher when compared to charcoal from other materials [8].

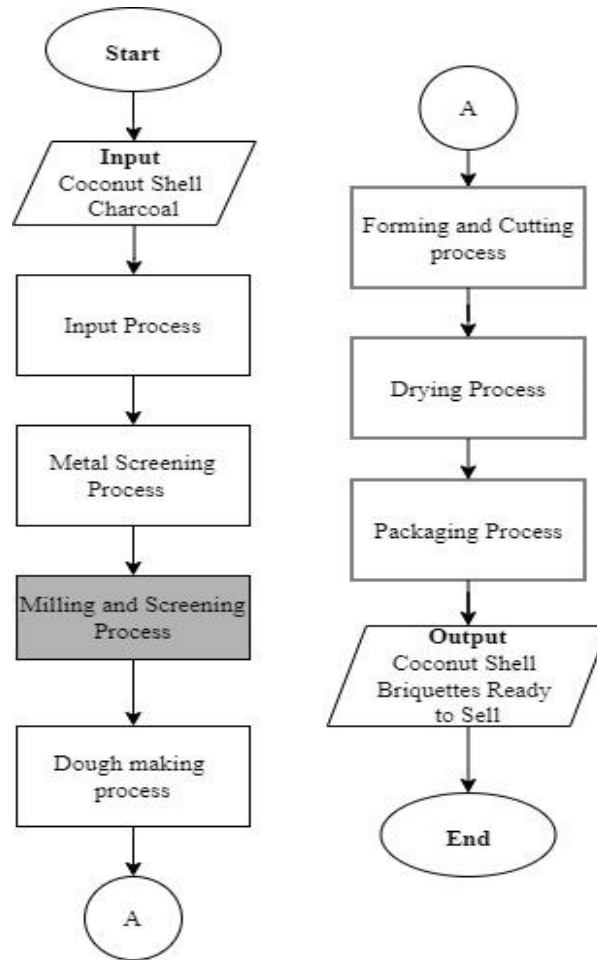

Figure 2 - Process Production of Charcoal Briquette

PT XYZ plans to produce coconut shell briquettes. Currently, PT XYZ already has a hammer mill machine that will be used in the production process. A hammer mill machine is a machine that is used to change the size of a material or material to a smaller size. Figure 2 explains seven processes in making briquettes with the input being coconut shell charcoal. The charcoal is fed into the bucket conveyor by the operator and then passes through the metal detector. This is done to prevent metal from entering the next process because metal can damage machine parts and affect briquette results. The next step is the charcoal will be ground and then filtered to obtain a certain size. The charcoal is then mixed with other ingredients such as tapioca flour and water so that it becomes a dough that is ready to be printed and shaped as desired so that it becomes briquettes. The briquettes that are still wet will be dried using an oven. The dry briquettes will then be packaged and ready to be sold.

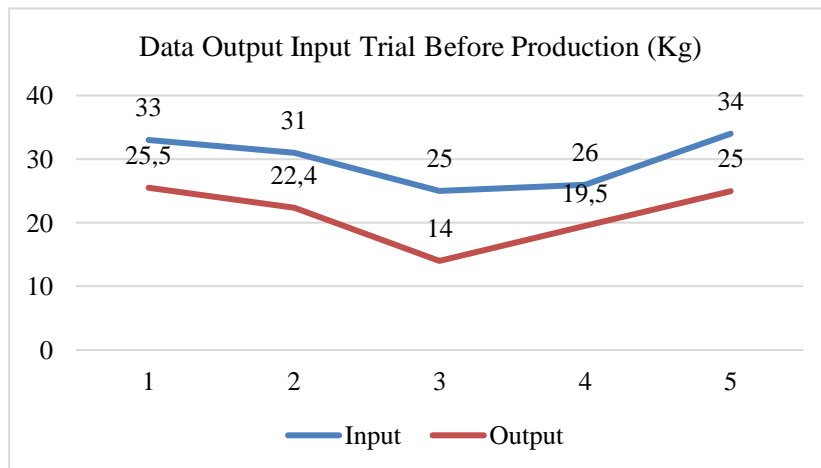

Figure 3 - Output and Input Data of Production Process Trial

Before mass production was carried out, PT. XYZ does the simulation first. Figure 3 describes the inputs and results of the five production simulations. Based on the graph, it is known that the production experiments concluded that from the average input given, namely 29.8 kg, the average output was only 21.28 kg or 71.41%. The manufacture of briquettes found obstacles in the process of grinding and screening. Coconut shell charcoal that has been milled and entered is partially retained and cannot be released to proceed to the next process. The remaining charcoal cannot pass through the screen or filter, causing the blade to stop rotating and the next experiment cannot be continued. After being measured, it is known that the particle size of the crushed charcoal is 1 to 2mm. This size is much larger than the screen size used. Based on the identification of the problem, the alternative solution chosen by the researcher is to redesign the hammer mill machine, especially on the blade and screen sections. Design redesign is the most significant factor in the splitting of material particles, or the material refining process compared to other factors such as increasing the speed of the hammer mill itself [3].

There are several previous studies related to the hammer mill machine and the process of making briquettes. However, in this study the design of hammer mill machine parts was limited because the production simulation was done manually, so it took time to make new parts and required more costs. In this study, each blade and screen design can be simulated using EDEM software. The software can simulate discrete element models by knowing the final milling sizes accurately.

2. METHODS

The reverse engineering method was used to carry out the design. Reverse engineering is the process of measurement, analysis, and testing to change the design or reconstruct an existing product [4]. It is a valuable tool in product design, as it allows us to take an existing product and improve upon it. It is also a method used to design and modify a product based on an existing product to obtain a better and more efficient product [5]. It involves five stages: investigation and prediction, concrete experience: function and form, design models, design analysis, and redesign. During the investigation and prediction stage, engineers analyze the existing product, making predictions and developing hypotheses about how it works. The second stage, concrete experience, involves testing and measuring the product to determine its function and form. During the third stage, design models are created to simulate the product to test different design ideas. Design analysis follows, in which the models are tested and analyzed to determine the best design. Finally, the product is redesigned, using parametric design, adaptive design, or original redesign. As shown in Figure 4, by following these five steps, engineers can create better more efficient products.

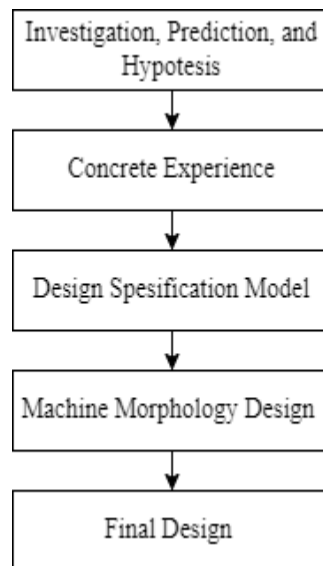

Figure 4 - Reverse Engineering Procedure

2.1. Investigation, prediction, and hypothesis

In the early stages, namely investigation, prediction, and hypothesis, the researcher looks for existing problems by collecting data or information. In this study, the data needed is a need statement from workers. The production process of making briquettes requires 2 workers. Both of them were interviewed to find out how the workers felt when using the machine, the advantages and disadvantages of the machine, as well as the improvements needed. In this study, no sampling was carried out because the number of workers in the production process was only two people so all of them could be interviewed. Table 1 gives the information about the user requirements that have been obtained:

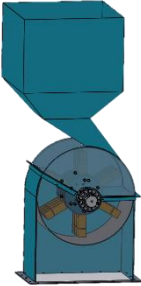

Table 1 - Need Statement



No.	Need Statement
1.	The machine can smooth quickly.
2.	The machine has a large capacity.
3.	The machine has a screen with a bigger hole.
4.	The machine has a thick blade.
5.	The machine can be used safely.
6.	The machine is easy to manufacture

2.2. Concrete Experience

The second stage is the concrete experience, namely the stage of determining the specifications of each component. The product will be disassembled to understand each of its parts so that it is hoped that ideas for redesigning will emerge based on user needs that have been obtained in the previous stages. Based on its function, the hammer mill machine can be divided into five parts, namely the upper case, bottom case, rotor, blade, and screen. Every part of the machine has an important role and cannot be eliminated. After doing this analysis it is known that the machine parts that play a role in the milling and screening processes are the blade and screen so further development needs to be done in these parts. The following is a decomposition of the existing hammer mill machine.

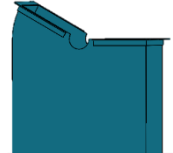
Table 2 - Decomposition of Hammer Mill Machine

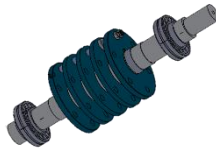
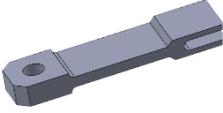
Existing Hammer Mill Machine		
		
No.	Component	Function
Upper Case		
1.		The upper-case functions to receive coconut shell charcoal input from the metal screening process at the metal detector to the grinding process.
Bottom Case		
2.		The bottom case is a place to put the screen and becomes a link for the coconut shell material which has been mashed with a conveyor to go to the next process.

3. **Rotor**
- 
- The rotor is where the blade is attached as well as the rotation axis in the coconut shell charcoal grinding process.
4. **Blade**
- 
- The blade is the main component of a crusher or pounder in the milling process.
5. **Screen**
- 
- The screen serves as a filter material with a certain size. If the size of the material is larger than the screen hole, then the material will again undergo the grinding process, if it is smaller then the material will pass through the hole and go to the next process.

2.3. Target Design Specifications

After determining the engine decomposition in the previous section, the steps that must be taken care to determine the target engine specifications. Target engine specifications are determined based on technical requirements determined from the needs statement. The target specification of the machine is used as an illustration regarding the proposed machine that will be made and whether it can answer the needs of workers. The determination of the target for each specification is based on expert judgment, existing machines, and literature studies. Table 3 is the target specifications of each of the technical specifications that have been determined.

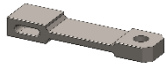
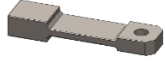
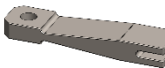
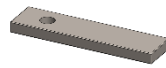

Table 3 - Product Specification

No.	Technical Needs	Target	Unit	Reference
1.	Engine speed	$\geq 1,440$	rpm	Expert Judgement
2.	Machine capacity	≥ 60	kg	existing machine
3.	Screen size	40	mesh	[1]
4.	Blade thickness	>20	mm	existing machine
5.	Machine case closed	Yes/No	Binary	existing machine
6.	Easy to manufacture	Yes/No	Binary	[2]

2.4. Machine Morphology

Machine morphology analysis is a step to bring up alternative concepts in design by going through two stages, namely machine morphology maps and function compatibility. The following is a morphological map of the machines in this study. The machine morphology map is a map of alternative solutions consisting of an arrangement of sub-solutions from designs that are combined to produce design alternatives that are suitable with the target specifications. The alternative solutions shown are designs on the market and designs that have been made based on existing products. The design is done using 3D software or Computer Aided Design (CAD) software. At this stage, several design options are obtained that will be developed.

Table 4 - Machine Morphology Map

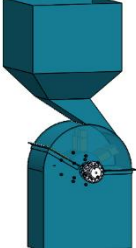
Function	1 st alternative	2 nd Alternative	3 rd Alternative	4 th Alternative
Blade Design	1 st Design 	2 nd Design 	3 rd Design 	4 th Design 
Screen Design	30 mesh 		40 mesh 	
Case Design	Closed Case 			
Machine Speed	1.440 rpm			
Machine Capacity	60kg			

The fourth stage is design analysis, namely, at this stage, the design model that has been made is whether it meets the user needs or is it better than the existing product. Otherwise, the design cannot proceed to the next stage. Based on the alternatives that have been given, two options do not suit the needs, namely the design of blade 4 and screen 30 mesh so that the final alternative is obtained as follows:

Table 5 - Combination Map

Combination	A	B	C
Blade design	1 st Design	2 nd Design	3 rd Design
Screens design	40 mesh	40 mesh	40 mesh
Case design	Fully closed case	Fully closed case	Fully closed case
Machine capacity	60 kg	60 kg	60 kg
Engine speed	1.440 rpm	1.440 rpm	1.440 rpm

The last stage is the redesign stage. The next step is to form several alternatives in selecting the concept from the design selected from the previous phase and selecting the design that best suits your needs. To select the design to be made, concept scoring is carried out. The weight value is done by conducting a survey of the operator based on the existing specifications.

Table 6 - Concept Screening

Selection Criteria	Weight	Concept					
		A		B		C	
		Rating	Weight Value	Rating	Weight Value	Rating	Weight Value
The machine can smooth quickly.	18,18%	4	0,727	4	0,727	4	0,727
The machine has a large capacity.	13,64%	3	0,409	3	0,409	3	0,409
The machine has a screen with a bigger hole.	18,18%	4	0,727	4	0,727	4	0,727
The machine has a thick blade.	18,18%	3	0,545	4	0,727	3	0,545
The machine can be used safely.	13,64%	3	0,409	3	0,409	3	0,409
The machine is easy to manufacture	18,18%	2	0,364	4	0,727	3	0,545
Final score		3,182		3,727		3,364	
Rating		3		1		2	
Continue?		No		Yes		No	

Based on the results of the concept screening, it was found that concept A had a final score of 3.182 and was ranked 3rd; concept B has a final score of 3.727 with a rating of 1; and concept C has a final score of 3.364 with a rating of 2. Because concept B has a higher final score than the other two concepts, the concept that will be developed further is concept B.

3. RESULT AND DISCUSSION

Figure 5 displays a selected design model made using Solidworks software. To determine the size of the coconut shell charcoal material in the grinding process, each blade will be simulated using the breakage feature EDEM software. This feature is the newest feature of the EDEM 2022.1 software. The input material in the form of charcoal will be simulated into a hammer mill machine and will be crushed using a blade. Each blade has the same speed (control variable) which is equal to 1440 rpm, the type of machine material, and the amount and type of coconut shell charcoal are made the same and the independent variable is blade design. In this study, two simulations were carried out for each blade so that a total

of six simulations were obtained. Each simulation is made for 1 second so that for one type of blade, 2 seconds of simulation are obtained. This is done so that the simulation results that have been made become more valid.

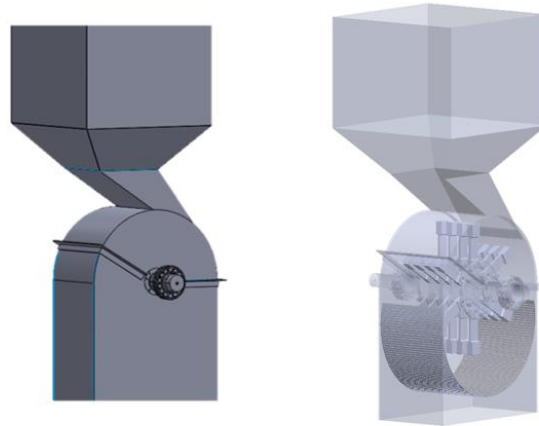

Figure 5 - Selected Design

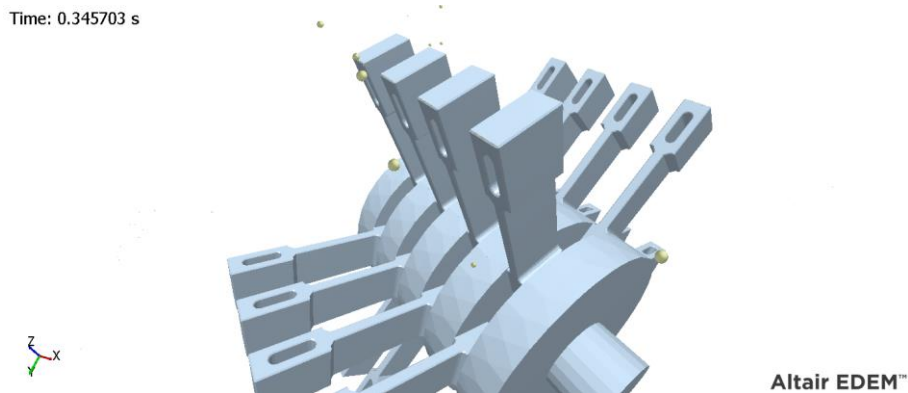

Figure 6 - Blade 1 Simulation on EDEM Software

After conducting simulations using EDEM software, it was found that the average size of the coconut shell charcoal material from the two blades 1 simulation was 0.531 mm. In the experiment using the first simulation, an average of 0.466 mm was obtained and in the second simulation, it was 0.597 mm. The results of this measurement are considered not by the desired specifications because the screen size is 40 mesh or 0.4 mm so the average size of the charcoal material in the grinding process is much larger with a difference of 0.131mm.

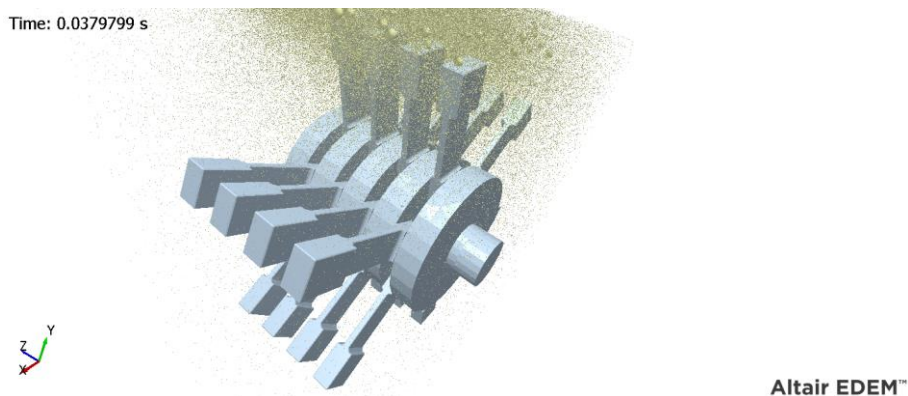

Figure 7 - Blade 2 Simulation on EDEM Software

Based on the simulations that have been carried out using the EDEM software, it is found that the average size of the milled results using blade 2 is 0.365 mm. In the first experiment, an average of 0.387 mm was obtained and in the second experiment, it was 0.343 mm. The simulation results show that the milling process uses blade 2 according to specifications smaller than screen 40 mesh which is 0.4mm.

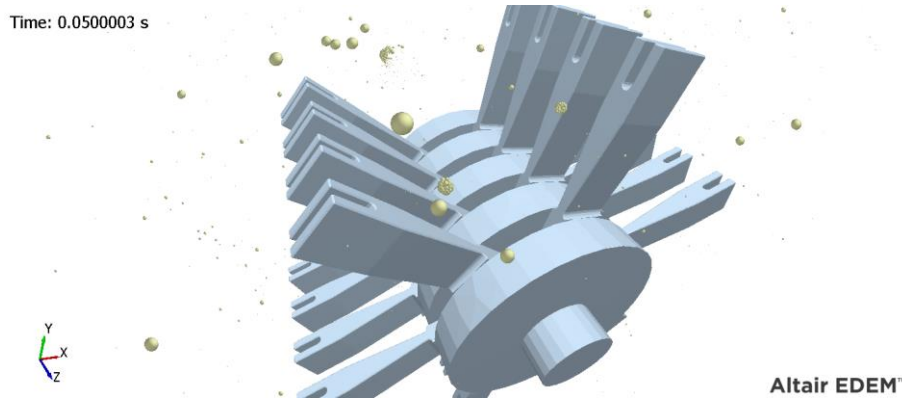

Figure 8 - Blade 3 Simulation on EDEM Software

In the first simulation of the milling process using the third blade, the average diameter of the coconut shell material was 0.402 mm. Then in the second simulation, an average of 0.406mm was obtained. Therefore, the final average value of the simulated diameter using the third blade is 0.404 mm. This value is the value closest to the screen specifications, which is 0.4 mm, but this value is larger in size so the milling results are still considered not to meet the desired specifications.

Based on the results of the simulation that has been carried out, it is known that the milling process according to specifications is grinding using blade 2, which has an average diameter of 0.365 mm. Therefore, the milling process to be verified is milling using blade 2.

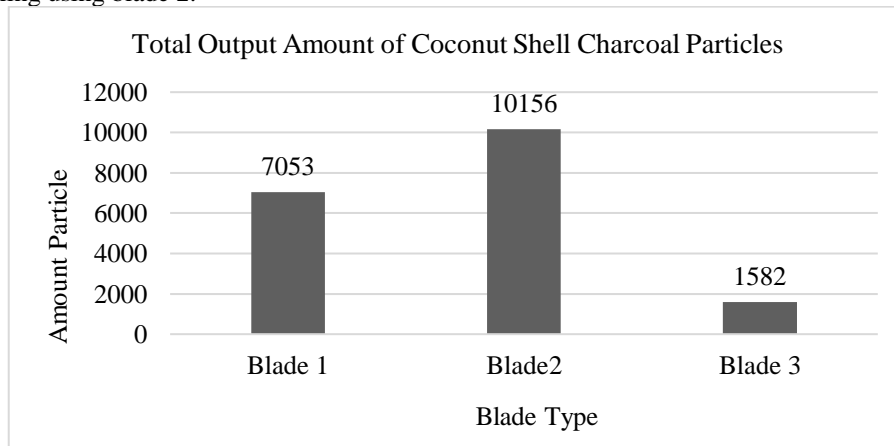

Figure 9 - Total Amount of Coconut Shell Charcoal Particles

In the milling process, with the input of the same amount of coconut shell charcoal material, a different amount of output is produced. The second blade produced the largest number of particles, namely 10,156 particles. This can be interpreted as the fastest grinding process being on the second blade with the same total time on each blade, which is 2 seconds.

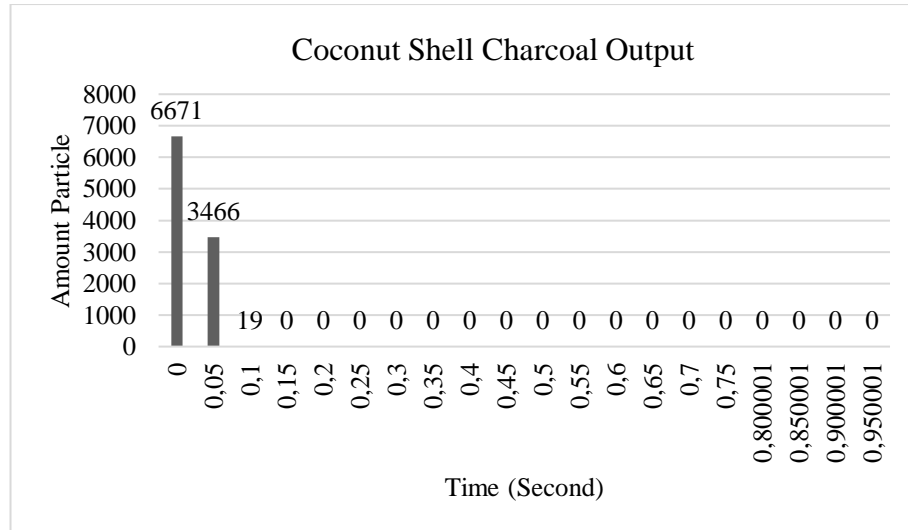

Figure 10 - Coconut Shell Charcoal Output in EDEM

As shown in Figure 10, it is known that at 0.1 seconds all coconut shell charcoal particles have been successfully processed. It is known that the total mass of input particles is 0.01597 kg, namely from adding up the total mass of charcoal and charcoal dummy as in the simulation results as follows: If the time needed to process 0.01597 kg is 0.1 seconds, then the time needed to process one cycle coconut shell charcoal which is as much as 29.8 kg is for 186.607 seconds. When compared with the existing processing time of 300 seconds, the processing using the design system is 113.397 seconds faster.

4. CONCLUSION

Based on the results of data processing and analysis that has been carried out, it is concluded that the results of the selected design are the second design concept with the second design blade component, the screen size of 40 mesh, fully closed case, engine capacity of 60 kg, and engine speed of 1440 rpm. Based on the simulations that have been carried out using the EDEM 2022.1 software, the selected design meets the desired specifications because the average size of the milled product is 0.343mm. On the other hand, the use of the new design causes the grinding time for one cycle to be faster, which is 186.607 seconds, compared to the existing time, which is 300 seconds. Suggestions from researchers are to develop other designs for hammer mill machine parts, especially in the milling and screening process to obtain more effective and efficient production results. For further research, it is suggested to use ergonomic factors in developing designs.

Disclaimer

The authors whose names are written certify that they have no conflict of interest

REFERENCES

- [1] S. Suryaningsih, P. M. Anggraeni and O. Nurhilal, "Pengaruh Ukuran Partikel Terhadap Kualitas Termal dan Mekanik Briket Campuran Arang Sekam Padi dan Kulit Kopi," *Jurnal dan Material Energi Indonesia*, vol. 9, pp. 79-85, 2019.
- [2] R. Nur and M. A. Suyuti, *Perancangan Mesin-Mesin Industri*, Sleman: CV Budi Utama, 2017.
- [3] A. Efendi and R. Suhartono, "Perbaikan dan Pemeliharaan mesin Disc Mill Bonggol Jagung," *Jurnal Mesin Nusantara*, vol. 2, pp. 42-51, 2019.
- [4] S. Zikovic, L. Cerce, J. Kostic, V. Majstorovic and D. Kramar, "Reverse Engineering of Turbine Blade Kaplan's Type for Small Hydroelectric Power Station," *15th CIRP Conference on Computer Aided Tolerancing*, vol. 75, pp. 379-384, 2018.
- [5] Suseno and T. T. Huvat, "Perancangan Alat panggang Otomatis Menggunakan Metode QFD (Quality Function Deployment)," *Jurnal Teknologi*, vol. 12, pp. 123-129, 2019.
- [6] K. N. Otto and K. L. Wood, "A Reverse Engineering and Redesign Methodology for Product Evolution," *The 1996 ASME Design Engineering Technical Conference and Design Theory and Methodology Conference*, vol. 10, pp. 1-19, 1996.
- [7] Sugiono, *Metodologi Penelitian dan Pengembangan Research and Development*, Bandung: Alfabeta CV, 2015.
- [8] M. R. Lehto and J. R. Buck, *Introduction to Human Factors and Ergonomics for Engineers*, New York: Lawrence Erlbaum Associates, 2008.
- [9] H. R. Zadry and e. al, *Analisis dan Perancangan Sistem Kerja*, Padang: Andalas University Press, 2015.
- [10] A. R. T. J. H. Sitalaksana, *Teknik Perancangan Sistem Kerja*, Bandung: ITB, 2006.
- [11] Dassault System Solidworks, *Introducing Solidworks*, Waltham: Dassault System Solidworks, 2015.
- [12] M. Lombard, *Mastering SolidWorks*, Indianapolis: Sybex A Wiley Brand, 2019.

- [13] DEM Solution, EDEM 2.4 User Guide, Edinburg: DEM Solution, 2011.
- [14] S. J. Nugroho and N. Iskandar, "Karakteristik Blade Hammer Mill Type Swing," *Jurnal Teknik Mesin Universitas Diponegoro*, vol. 3, pp. 376-281, 2015.
- [15] R. Khurmi and J. Gupta, A Textbook of Machine Design, New Delhi: Eurasia Publishing House (PVT.) LTD., 2005.
- [16] P. Klit and N. L. Pedersen, Machine Elements Analysis and Desain, Lativa: Polteknisk Forlag, 2014.
- [17] Indriyani, "Peningkatan Kemampuan Mesin Hammer Mill Pengupas Coklat Kapasitas 100 Kg per Jam," *Jurnal Teknika Sains*, vol. 4, pp. 41-48, 2019.
- [18] C. Ajayi, F. Oyawale and S. Afolalu, "Development of Blender Hammer Mill for Multipurpose Use," *International Conference on Engineering for Sustainable World Journal of Physics: Conference Series*, pp. 1-7, 2019.
- [19] C. Ajayi, F. Oyawale and S. Afolalu, "Optimization and Performance Evaluation of Blender Hammer Mill," *International Conference on Engineering for Sustainable World Journal of Physics: Conference Series*, pp. 1-8, 2019.
- [20] A. N. Hendrawan, A. Kusnayat and Y. N. D. Yekti, "Uji Tingkat Keausan Blade pada Mesin Hammer Mill Menggunakan Metoda Finite Element Methods (FEM)," *e-Proceeding of Engineering Vol. 8*, pp. 2609-2616, 2021.
- [21] A. I. Munandar, A. H. Darjono and Z. Aprilansani, Pembangunan Berkelanjutan : Studi Kasus di Indonesia, Jakarta: By Pass, 2019.
- [22] B. Kusmartono, A. Situmorang and M. Yuniwati, "Pembuatan Briket dari Tempurung Kelapa (Cocos Nucivera) dan Tepung Terigu," *Jurnal Teknologi*, vol. 14, pp. 142-149, 2021.
- [23] P. W. Anggoro, B. bawono and I. Sujatmiko, "Reverse Engineering Technology in Redesign Process Ceramics : Application for CNN Plate," *Procedia Manufacturing 4*, vol. 4, pp. 521-527, 2015.
- [24] W. Wang, Reverse Engineering Technology of Reinvention, New York: CRC Press Taylor and Francis Group, 2011.
- [25] S. Kurniawan and A. Kusnayat, "Perancangan mesin Hammer pada mesin hammer mill menggunakan metoda Discrete Element Modelling untuk Meningkatkan Kehalusan Pengilingan Kulit Kopi," *JRSI*, vol. 3, pp. 21-24, 2016.
- [26] Badan Pengkajian dan Penerapan Teknologi, "Outlook Energi Indonesia 2021 : Perspektif Teknologi Energi Indonesia," Pusat Pengkajian Industri Proses dan Energi , Jakarta, 2021.
- [27] A. I. Agung, "Potensi Sumber Energi Alternatif dalam Mendukung Kelistrikan Nasional," *Jurnal Pendidikan Teknik Elektro Unesa*, vol. 2, pp. 892-897, 2013.